



RÜSCH TRACHEOSTOMY

The optimum choice for all application



THE OPTIMUM TUBE FOR ALL APPLICATIONS

Teleflex’s extraordinarily large and diverse range of RÜSCH tubing fulfils the highest expectations. The optimised ratio between inner and outer diameter is characteristic of all RÜSCH tubes. The special manufacturing process employed allows the thickness of the tube wall to be minimised while simultaneously maintaining high stability. High-grade materials, that have been exhaustively tested according to medical criteria, reflect our understanding of high quality.

THE RIGHT SOLUTION

With its comprehensive RÜSCH tracheostomy programme, Teleflex offers the ideal solution for every clinical indication. From acute medicine through the ENT area to the demands of long-term tracheostomy and paediatrics: RÜSCH provides coordinated sets, which save time and money. Set components that can be reordered individually make the sets even more economical.

	Acute area	ENT	Long-term application	Paediatrics
TracheoFlex S	x	x	x	x
TracFlex Plus	x	x	x	
Ultra TracheoFlex	x	x	x	
TracheoFlex	x	x	x	x
TracheoFix	x	x	x	
CrystalClear Plus	x	x		x
Biesalski		x	x	x
SafetyClear	x			
PercuQuick	x			
PercuTwist	x			

SAFETY AT A GLANCE

Atraumatic tips and rotating connectors, for example in CrystalClear Plus tubes, make tracheostomy as simple and gentle as possible. A full-length X-ray marker allows the position to be checked easily.

VARIETY FROM ONE HAND

Tracheostomy tubes from RÜSCH are available in numerous versions: with or without Widescope (low-pressure) cuff, with or without phonation window, with adjustable flange, and armoured, e.g. the TracheoFlex tubes, to prevent kinking and compression.

FLEXIBLE AND ADAPTABLE

RÜSCH tracheostomy tubes fit the patient’s anatomy without pressure or tension. The optimised ratio between inner and outer diameter allows the greatest possible inner lumen. And the auxiliary equipment – for example the innovative adaptation and attachment mechanism of the TracheoFix tubes – facilitates handling.

DIMENSIONS ACC. TO DIN EN ISO 5366-1 & 5366-3

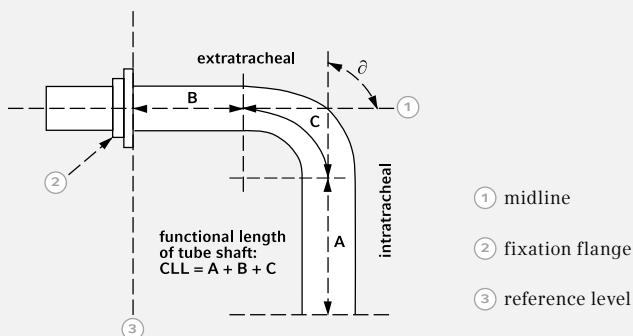

 Paediatric sizes available



ARMoured TRACHEOSTOMY TUBES	2
Tracflex Plus	2
TracheoFlex	4
STANDARD TRACHEOSTOMY TUBES	10
CrystalClear Plus	10
SafetyClear	12
PRESHAPED TRACHEOSTOMY TUBES	13
TracheoFix	13
Biesalski	16
TRACHEOSTOMY TUBES FOR PAEDIATRICS	17
TracheoFlex	17
CrystalClear Plus	18
Biesalski	19
PERCUTANEOUS TRACHEOSTOMY (PDT)	20
PDT Tracheostomiekanülen-Sets	21
PercuTwist	22
PercuQuick Multi-Step	24
PercuQuick One-Step	25
SPECIAL PRODUCTS	26
TracheoQuick	26
TracheoPart	27
LaryngoFlex	28
TPS MultiFlex	29
ACCESSORIES	30

ARMoured TRACHEOSTOMY TUBES

TRACFLEX PLUS

ARMoured TUBE MADE OF THERMOSENSITIVE PVC, DEHP-FREE

The latest generation of Teleflex's armoured tracheostomy tubes made by RÜSCH offer a real "plus" in terms of comfort, safety and performance. The atraumatic tips of the tube and insertion aid allow patient-friendly introduction and are gentle on the patient's skin and trachea. A thin-walled low-pressure cuff safely and gently seals the trachea in the low-pressure area. The adaptable fixation flange system with its simple locking system allows safe and precise adjustment to

suit the patient's neck. With its anatomically shaped and armoured shaft made of thermosensitive, DEHP-free PVC, the TracFlex Plus tracheostomy tube is highly flexible and kink-resistant, ensuring maximum freedom of movement for the patient. Thanks to the flexible inner cannula system secretions can be removed in a very easy and hygienic manner, thus minimising the risk of contaminating the inner lumen of the tracheostomy tube.

TRACFLEX PLUS TUBE

- siliconised
- atraumatic tip
- with cuffed versions:
 - valve for Luer and Luer-lock syringe tips with valve sealing cap
 - blue pilot balloon
 - low-pressure cuff
- fixed 15 mm connector
- soft, movable, colour coded fixation flange with unique safe locking mechanism
- radiopaque
- latex-free, DEHP-free
- sterile
- single patient use



TRACFLEX PLUS TUBE

RÜSCH

ORDER SIZE / I.D.	O.D.	TOTAL LENGTH (CLL=A+B+C)	DIM. A	DIM. B	DIM. C	ANGLE θ (APPROX.)	CUFF ø *	INNER CANNULA	QTY
● 7.0	10.1 mm	102.5 mm	37.0 mm	22.8 mm	42.7 mm	100°	23 mm	7.0	2
● 8.0	11.1 mm	122.5 mm	40.0 mm	25.4 mm	57.1 mm	100°	27 mm	8.0	2
● 9.0	12.1 mm	152.5 mm	44.0 mm	26.4 mm	82.1 mm	100°	30 mm	9.0	2
● 10.0	13.1 mm	157.5 mm	44.0 mm	34.0 mm	79.5 mm	100°	32 mm	10.0	2
● 11.0	14.2 mm	163.5 mm	47.0 mm	33.1 mm	83.4 mm	100°	34 mm	11.0	2

* only for 121903 TracFlex Plus Set

TRACFLEX PLUS SET
with cuff

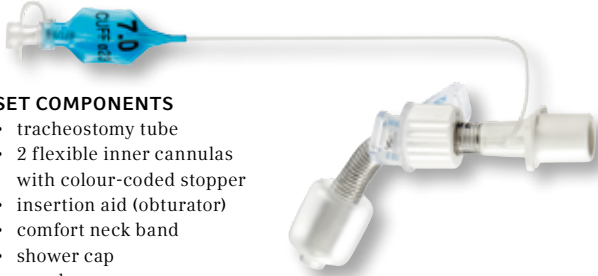

SET COMPONENTS

- tracheostomy tube
- 2 flexible inner cannulas with colour-coded stopper
- insertion aid (obturator)
- comfort neck band
- shower cap
- cough cap
- water-soluble lubricating jelly, 3g sachet
- tracheostomy tube patient card

REF.	ORDER SIZE/I.D.	QTY
121903	7.0-11.0	2

TRACFLEX PLUS SET
without cuff



SET COMPONENTS

- tracheostomy tube
- 2 flexible inner cannulas with colour-coded stopper
- insertion aid (obturator)
- comfort neck band
- shower cap
- cough cap
- water-soluble lubricating jelly, 3g sachet
- tracheostomy tube patient card

REF.	ORDER SIZE/I.D.	QTY
121900	7.0-11.0	2

TRACFLEX PLUS INNER CANNULA

- colour coded stopper
- sterile
- single use



TRACFLEX PLUS INNER CANNULA *RUSCH*





REF.	ORDER SIZE	I.D.	O.D.	QTY
121910	● 7.0	5.5 mm	6.2 mm	10
	● 8.0	6.5 mm	7.2 mm	10
	● 9.0	7.8 mm	8.3 mm	10
	● 10.0	8.8 mm	9.4 mm	10
	● 11.0	9.8 mm	10.4 mm	10

TRACFLEX PLUS ACCESSORIES

- single use

TRACFLEX PLUS ACCESSORIES, SINGLE USE

RUSCH

	REF.	DESCRIPTION	QTY
	121911	shower cap for TracFlex Plus tubes, acting as a splash guard to prevent the entry or inhalation of water droplets during bathing or showering	4
	121912	cough cap for TracFlex Plus tubes, to channel expelled secretions downwards	4
	121913	sealing cap for TracFlex Plus tubes, for weaning therapy	4
	121915 **	insertion aid for safe and atraumatic introduction of the TracFlex Plus tracheostomy tube	1

** when ordering, please also indicate tube size

TRACHEOFLEX RANGE

ARMoured TUBE MADE OF THERMOSENSITIVE PVC

Soft and flexible. TracheoFlex tubes for acute use in the ENT area and intensive therapy are extremely flexible and adaptable. Provided with a thin-walled Widescope (low-pressure) cuff, they seal the trachea securely. The TracheoFlex S range is the right choice for the long-term care of tracheostomy patients and during weaning from

the ventilator. The soft adaptable material of the two tracheostomy systems enables them to be introduced atraumatically, and it is gentle on the trachea. The armoring renders the tubes very stable and prevents kinking or compression.

ULTRA TRACHEOFLEX TUBE

- siliconised
- atraumatic tip
- with cuffed versions:
 - valve for Luer and Luer-lock syringe tips
 - blue pilot balloon
 - low-pressure cuff
- fixed 15 mm connector
- soft, movable fixation flange
- radiopaque
- latex-free
- sterile
- single patient use

ULTRA TRACHEOFLEX TUBE

RUSCH

ORDER SIZE/ I.D. O.D.		TOTAL LENGTH (CLL=A+B+C) REF. 120304	TOTAL LENGTH (CLL=A+B+C) REF. 120347	TOTAL LENGTH (CLL=A+B+C) REF. 120378	DIM. A	DIM. B	DIM. C	ANGLE θ (APPROX.)	CUFF Ø
7.0 mm	10.4 mm	63.0 mm	113.0 mm	103.0 mm	32.0 mm	3.0 mm	28.0 mm	90°	22 mm
8.0 mm	11.4 mm	88.0 mm	138.0 mm	128.0 mm	32.0 mm	21.0 mm	35.0 mm	90°	24 mm
9.0 mm	12.4 mm	117.0 mm	167.0 mm	157.0 mm	42.0 mm	40.0 mm	35.0 mm	90°	25 mm
10.0 mm	13.4 mm	117.0 mm	167.0 mm	157.0 mm	46.0 mm	36.0 mm	35.0 mm	90°	26 mm
11.0 mm	14.4 mm	116.0 mm	166.0 mm	156.0 mm	43.0 mm	34.0 mm	39.0 mm	90°	28 mm

ULTRA TRACHEOFLEX SET
with cuff



- SET COMPONENTS**
- tracheostomy tube
 - comfort neck band
 - insertion aid (catheter)

SPECIAL FEATURE
Set for PDT for Ultra TracheoFlex (Ref. 12 03 48)
available, see page 21

REF.	ORDER SIZE/I.D.	QTY
120304	7.0-11.0	5

LENGTH VERSION OF ULTRA TRACHEOFLEX SET
with cuff

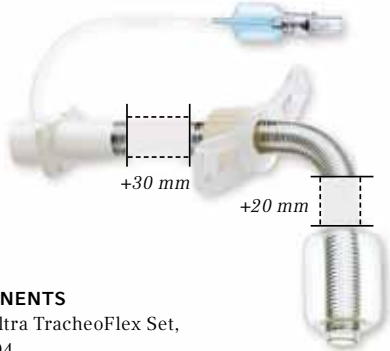

- SET COMPONENTS**
- same as Ultra TracheoFlex Set, Ref. 120304
 - length version:
intratracheal length: + 20 mm
extratracheal length: + 30 mm

REF.	ORDER SIZE/I.D.	QTY
120347	7.0-11.0	5

LENGTH VERSION OF ULTRA TRACHEOFLEX SET
with cuff



- SET COMPONENTS**
- same as Ultra TracheoFlex Set, Ref. 120304
 - length version:
extratracheal length: + 40 mm

REF.	ORDER SIZE/I.D.	QTY
120378	7.0-11.0	5

We recommend lubricating the tips of the tube, the insertion aid and the suction catheter with a small amount of a water-soluble lubricant prior to

use in order to facilitate the intubation process. Because of the risk of slipping, the flange screw should **not** come into contact with the lubricant.

TRACHEOFLEX TUBE

- siliconised
- atraumatic tip
- with cuffed versions, especially for short-term blockage:
 - valve for Luer and Luer-lock syringe tips
 - transparent pilot balloon
 - high-pressure cuff
- fixed 15 mm connector
- soft, movable fixation flange (size 7.0 – 12.0)
- fixation flange with screw threaded ring (size 3.0 – 6.0)
- radiopaque
- latex-free
- sterile
- single patient use



a) Movable fixation flange with unique locking mechanism in sizes I.D. 7.0 – 12.0 mm



b) Fixation flange with screw threaded ring in sizes I.D. 3.0 – 6.0 mm

TRACHEOFLEX TUBE

RÜSCH

	ORDER SIZE/ I.D.	O.D.	TOTAL LENGTH (CLL=A+B+C)	DIM. A	DIM. B	DIM. C	ANGLE θ (APPROX.)	CUFF Ø*	FIXATION FLANGE TYPE
Paediatrics	3.0 mm	5.0 mm	45.0 mm	11.0 mm	15.0 mm	19.0 mm	90°	–	b
	4.0 mm	6.0 mm	55.0 mm	14.0 mm	21.0 mm	20.0 mm	90°	–	b
	5.0 mm	7.0 mm	59.0 mm	18.0 mm	19.0 mm	22.0 mm	90°	–	b
	6.0 mm	8.4 mm	64.0 mm	21.0 mm	19.0 mm	24.0 mm	90°	–	b
Adult	7.0 mm	10.4 mm	63.0 mm	32.0 mm	3.0 mm	28.0 mm	90°	10.4 mm	a
	8.0 mm	11.4 mm	88.0 mm	32.0 mm	21.0 mm	35.0 mm	90°	11.4 mm	a
	9.0 mm	12.4 mm	117.0 mm	42.0 mm	40.0 mm	35.0 mm	90°	12.4 mm	a
	10.0 mm	13.4 mm	117.0 mm	46.0 mm	36.0 mm	35.0 mm	90°	13.4 mm	a
	11.0 mm	14.4 mm	116.0 mm	43.0 mm	34.0 mm	39.0 mm	90°	14.4 mm	a
	12.0 mm	15.4 mm	116.0 mm	41.0 mm	34.0 mm	41.0 mm	90°	15.4 mm	a

* only for 120504 Tracheoflex Set

TRACHEOFLEX SET
with high-pressure cuff

SET COMPONENTS

- tracheostomy tube
- comfort neck band
- insertion aid (catheter)

REF.	ORDER SIZE/I.D.	QTY
120504	7.0–12.0	5

TRACHEOFLEX SET
without cuff

SET COMPONENTS

- tracheostomy tube
- comfort neck band
- insertion aid (catheter)

REF.	ORDER SIZE/I.D.	QTY
120502	3.0–11.0	5

EXTRA TRACHEOFLEX TUBE

- siliconised
- in the form of an arc
- atraumatic tip
- low-pressure cuffed:
 - valve for Luer and Luer-lock syringe tips
 - blue pilot balloon
 - low-pressure cuff
- fixed 15 mm connector
- soft, movable fixation flange
- radiopaque
- latex-free
- sterile
- single patient use

EXTRA TRACHEOFLEX TUBE**RÜSCH**

I.D.	O.D.	TOTAL LENGTH (CLL=A+B+C)	CUFF Ø
7.5 mm	10.3 mm	155.0	22 mm
8.5 mm	11.3 mm	155.0	24 mm
9.5 mm	12.3 mm	155.0	25 mm
10.5 mm	13.3 mm	155.0	26 mm

EXTRA TRACHEOFLEX SET

with cuff

**SET COMPONENTS**

- tracheostomy tube
- comfort neck band
- insertion aid (catheter)

REF.	ORDER SIZE/I.D.	QTY
120204	7.5-10.5	2

TRACHEOFLEX S TUBE

- siliconised
- atraumatic tip
- with or without phonation window
- with cuffed versions:
 - valve for Luer and Luer-lock syringe tips
 - blue pilot balloon
 - low-pressure cuff
- with or without phonation window
- soft fixation flange
- radiopaque
- latex-free
- sterile
- single patient use

SET COMPONENTS
multifunctional connector set with screw cap

- ① sealing cap
- ② phonation valve
- ③ 15 mm connector
- ④ cough cap
- ⑤ insertion aid
- ⑥ inner cannula

TRACHEOFLEX S TUBE

RUSCH

	ORDER SIZE/ I.D.	O.D.	TOTAL LENGTH (CLL=A+B+C)	DIM. A	DIM. B	DIM. C	ANGLE θ (APPROX.)	CUFF Ø
Paed.	6.0 mm	9.4 mm	49.0 mm	18.0 mm	–	31.0 mm	106°	18 mm
Adult	7.0 mm	10.4 mm	71.0 mm	31.0 mm	–	40.0 mm	101°	22 mm
	8.0 mm	11.4 mm	77.0 mm	36.0 mm	–	41.0 mm	95°	24 mm
	9.0 mm	12.4 mm	76.0 mm	34.0 mm	–	42.0 mm	95°	25 mm
	10.0 mm	13.4 mm	89.0 mm	40.0 mm	–	49.0 mm	95°	26 mm
	11.0 mm	14.4 mm	87.0 mm	38.0 mm	–	49.0 mm	95°	28 mm

TRACHEOFLEX S SET
with cuff, without phonation window

SET COMPONENTS

- tracheostomy tube
- 15 mm connector
- cough cap
- 2 inner cannulas
- comfort neck band
- insertion aid (obturator)

REF.	ORDER SIZE/I.D.	QTY
120000	6.0–11.0	2

TRACHEOFLEX S SET
with cuff, with phonation window

SET COMPONENTS

- tracheostomy tube with phonation window
- phonation valve
- sealing cap
- 15 mm connector
- cough cap
- 2 inner cannulas
- comfort neck band
- insertion aid (obturator)

REF.	ORDER SIZE/I.D.	QTY
120001	6.0–11.0	2

TRACHEOFLEX S SET
without cuff, without phonation window



SET COMPONENTS

- tracheostomy tube
- 15 mm connector
- cough cap
- 2 inner cannulas
- comfort neck band
- insertion aid (obturator)

REF.	ORDER SIZE/I.D.	QTY
120100	6.0–11.0	2

TRACHEOFLEX S SET
without cuff, with phonation window



SET COMPONENTS

- tracheostomy tube with phonation window
- phonation valve
- sealing cap
- 15 mm connector
- cough cap
- 2 inner cannulas
- comfort neck band
- insertion aid (obturator)

REF.	ORDER SIZE/I.D.	QTY
120101	6.0–11.0	2

Caution: When using tracheostomy tubes without a phonation window, the phonation valve should not be attached when the cuff is blocked (airway obstruction). When using a phonation valve or a sealing cap, only use tracheostomy tubes with a phonation window and deflate any cuffs prior to use. Also remove the inner cannula, if present, from the tube first.

TRACHEOFLEX S INNER CANNULA

- without phonation opening
- atraumatic tip
- with low-profile connector
- sterile
- single use

Fixation through accessories, such as the 15 mm connector or the cough cap.

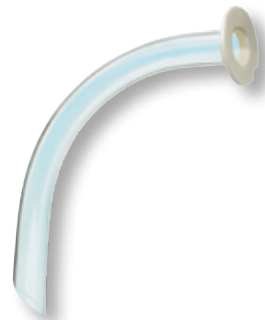

TRACHEOFLEX S INNER CANNULA *RÜSCH*

REF.	ORDER SIZE	I.D.	O.D.	QTY
858135	6.0	4.0 mm	5.0 mm	1
	7.0	5.0 mm	6.0 mm	1
	8.0	6.0 mm	7.0 mm	1
	9.0	7.0 mm	8.0 mm	1
	10.0	8.0 mm	9.0 mm	1
	11.0	9.0 mm	10.0 mm	1

STANDARD TRACHEOSTOMY TUBES

Superior safety, comfort and economy. Standard tracheostomy tubes from RÜSCH are distinguished by top quality and are particularly cost effective: the high-quality soft plastic material adapts perfectly, and thanks to the special fixation flange design ensures the greatest comfort

during use. The optimised ID-OD ratio keeps airway resistance low. The rotating connector of the CrystalClear Plus means the tube is as safe as possible for the patient.

CRYSTALCLEAR PLUS

ADVANCED TUBE SYSTEM WITH A FLEXIBLE INNER CANNULA SYSTEM, MADE OF THERMOSENSITIVE PVC

The Teleflex CrystalClear Plus tracheostomy tube set from RÜSCH is an advanced tube system with a flexible inner cannula system. It is distinguished by top quality, safety, high wearing comfort and economy. The thermosensitive, soft plastic material adapts perfectly to the patient's anatomy. Secretions are removed simply and efficiently at an early stage of accumulation through frequent changes of the

inner cannula, while protecting the inner tube lumen against contamination. Including an open and transparent fixation flange and an integrated rotating connector, this system ensures the greatest safety and comfort during use. The CrystalClear Plus tracheostomy tube is for single use only. The tubes are available with and without low-pressure cuffs and also come in intermediate sizes.

- integrated rotating 15 mm connector
- with cuffed versions:
 - valve for Luer and Luer-lock syringe tips
 - blue pilot balloon
 - low-pressure cuff starting from size 6
- colour-coded tube neckplate
- continuous X-ray marker along the tube shaft
- latex-free
- sterile
- single use

SET COMPONENTS

- ① 2 flexible inner cannulas with colour-coded stopper, starting from size 6
- ② insertion aid (obturator), starting from size 6
- ③ soft tracheostomy tube neck band
- ④ water-soluble lubricating jelly, 3 g sachet

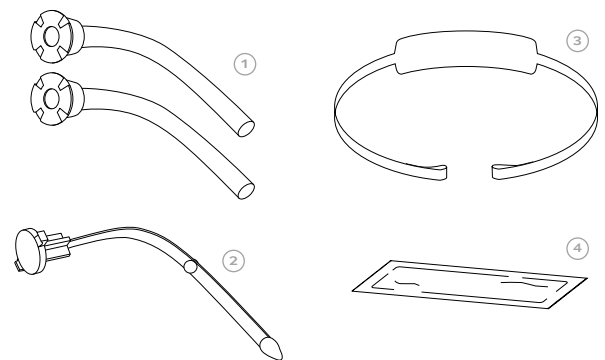

CRYSTALCLEAR PLUS TUBE

RÜSCH

	ORDER SIZE / I.D.	O.D.	TOTAL LENGTH (CLL=A+B+C)	DIM. A	DIM. B	DIM. C	ANGLE θ (APPROX.)	CUFF \varnothing *	INNER CANNULA
Paediatrics	● 3.5	5.3 mm	47 mm	17 mm	0	30 mm	95°	11 mm	–
	○ 4.0	5.9 mm	54 mm	18 mm	0	36 mm	95°	12 mm	–
	● 4.5	6.5 mm	54 mm	19 mm	0	35 mm	95°	14 mm	–
	● 5.0	7.0 mm	57 mm	20 mm	0	37 mm	95°	14 mm	–
	● 5.5	7.5 mm	58 mm	20 mm	0	38 mm	95°	15 mm	–
	● 6.0	8.7 mm	64 mm	25.5 mm	0	38.5 mm	95°	19 mm	6.0
	● 6.5	8.7 mm	64 mm	25.5 mm	0	38.5 mm	95°	19 mm	6.5
Adult	● 7.0	10.0 mm	70 mm	29.2 mm	0	40.8 mm	95°	21 mm	7.0
	● 7.5	10.7 mm	75.5 mm	30 mm	0	45.5 mm	95°	25 mm	7.5
	● 8.0	11.3 mm	81 mm	35.5 mm	0	45.5 mm	95°	28 mm	8.0
	● 8.5	11.3 mm	81 mm	35.5 mm	0	45.5 mm	95°	28 mm	8.5
	● 9.0	12.7 mm	87 mm	39.9 mm	0	47.1 mm	95°	28 mm	9.0
	● 9.5	12.7 mm	87 mm	39.9 mm	0	47.1 mm	95°	28 mm	9.5
	● 10.0	14.0 mm	95.5 mm	48.4 mm	0	47.1 mm	95°	30 mm	10.0

* only for 121303 CrystalClear Plus Set

CRYSTALCLEAR PLUS SET

with cuff

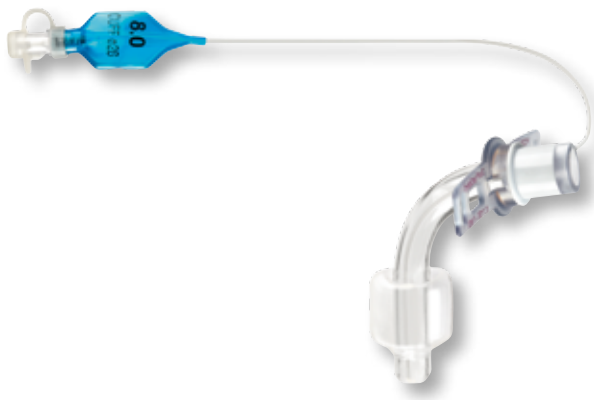

SET COMPONENTS

- tracheostomy tube
- 2 flexible inner cannulas with colour-coded stopper (\geq size 6)
- soft neck band
- insertion aid (obturator) (\geq size 6)
- water-soluble lubricating jelly, 3 g sachet

REF.	ORDER SIZE / I.D.	QTY
121303	3.5–10.0	5

CRYSTALCLEAR PLUS SET

without cuff



SET COMPONENTS

- tracheostomy tube
- 2 flexible inner cannulas with colour-coded stopper (\geq size 6)
- soft neck band
- insertion aid (obturator) (\geq size 6)
- water-soluble lubricating jelly, 3 g sachet

REF.	ORDER SIZE / I.D.	QTY
121300	3.5–10.0	5

CRYSTALCLEAR PLUS INNER CANNULA

- colour coded stopper
- sterile
- single use





CRYSTALCLEAR PLUS INNER CANNULA *RÜSCH*

REF.	ORDER SIZE	I.D.	O.D.	QTY
121310	● 6.0	5.0 mm	5.7	10
	● 6.5	5.0 mm	5.7	10
	● 7.0	6.0 mm	6.6	10
	● 7.5	6.8 mm	7.3	10
	● 8.0	7.0 mm	7.5	10
	● 8.5	7.0 mm	7.5	10
	● 9.0	8.3 mm	8.6	10
	● 9.5	8.3 mm	8.6	10
	● 10.0	9.3 mm	9.6	10

CRYSTALCLEAR PLUS ACCESSORIES

- single use

CRYSTALCLEAR PLUS ACCESSORIES

	REF.	DESCRIPTION	QTY
	121311	shower cap for CrystalClear Plus tubes, acting as a splash guard to prevent the entry or inhalation of water droplets during bathing or showering	4
	121312	Cough cap for CrystalClear Plus tubes, to channel expelled secretions downwards	4
	121313	Sealing cap for CrystalClear Plus tubes (for weaning therapy)	4

SAFETYCLEAR

TRACHEOSTOMY TUBE MADE OF THERMOSENSITIVE PVC

- siliconised
- fixed 15 mm connector
- low-pressure cuffed:
 - valve for Luer and Luer-lock syringe tips
 - blue pilot balloon
- continuous X-ray marker
- adaptable soft fixation flange
- latex-free
- sterile
- single use

SAFETYCLEAR SET
with cuff



- SET COMPONENTS**
- tracheostomy tube
 - comfort neck band
 - insertion aid (catheter)

REF.	ORDER SIZE/I.D.	QTY
121500	7.0 – 11.0	5

SAFETYCLEAR TUBE

RÜSCH

I.D.	O.D.	TOTAL LENGTH (CLL=A+B+C)	DIM. A	DIM. B	DIM. C	ANGLE θ (APPROX.)	CUFF Ø
7.0 mm	10.6 mm	71.0 mm	40.0 mm	–	31.0 mm	90°	21 mm
8.0 mm	11.6 mm	86.0 mm	40.0 mm	8.0 mm	38.0 mm	90°	23 mm
9.0 mm	12.7 mm	110.0 mm	45.0 mm	27.0 mm	38.0 mm	90°	24 mm
10.0 mm	13.8 mm	108.0 mm	44.0 mm	26.0 mm	38.0 mm	90°	25 mm
11.0 mm	14.9 mm	105.0 mm	41.0 mm	22.0 mm	42.0 mm	90°	27 mm

PRESHAPED TRACHEOSTOMY TUBES

TRACHEOFIX

TRACHEOSTOMY TUBE MADE OF THERMOSENSITIVE PVC

The TracheoFix tube can be used universally in intensive therapy, ENT and long-term care. As a result of the innovative adaptation and connecting mechanism for inner

cannula systems, neither the fixation flange nor the tracheostoma are touched when the tube is exchanged.

- with cuffed versions:
 - valve for Luer and Luer-lock syringe tips
 - blue pilot balloon
 - low-pressure cuff
- with or without phonation window
- multifunctional connector set with rotary locking mechanism (depending on version with phonation valve, cough cap, sealing cap, 15 mm connector, etc.)
- soft fixation flange, flexible in all directions, with letter coding
- fixation flange and inner cannula colour-coded according to size
- innovative connection mechanism for inner cannula systems (rotary locking)
- continuous X-ray marker along the tube shaft
- latex-free
- sterile
- single patient use

ACCESSORIES

Accessories for TracheoFix Set available separately.

See page 15

SPECIAL FEATURE

TracheoFix Set for PDT.

See page 21

SIMPLE AND SAFE IDENTIFICATION

1) Marking letters on the fixation flange:

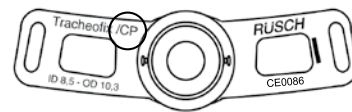

- C = Tube with cuff (without phonation)
 P = Tube with phonation (without cuff)
 CP = Tube with cuff and phonation
 = Tube without cuff and phonation

2) Coloured circle on the inner cannula and colour-code according to size:

interrupted coloured circle:
with phonation

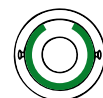

closed coloured circle:
without phonation

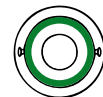

TRACHEOFIX TUBE

RUSCH

ORDER SIZE	I.D.	O.D.	TOTAL LENGTH (CLL=A+B+C)	DIM. A	DIM. B	DIM. C	ANGLE θ (APPROX.)	CUFF Ø
● 7.0	7.2 mm	9.0 mm	70.0 mm	–	–	70.0 mm	78°	27.0 mm
● 8.5	8.7 mm	10.3 mm	78.0 mm	–	–	78.0 mm	86°	27.0 mm
● 10.0	10.2 mm	12.3 mm	86.0 mm	–	–	86.0 mm	90°	32.0 mm
● 11.0	11.2 mm	13.3 mm	86.0 mm	–	–	86.0 mm	88°	35.0 mm

TRACHEOFIX TFC SET
with cuff, without phonation window



- SET COMPONENTS**
- tracheostomy tube
 - 2 colour-coded inner cannulas with 15 mm connector, premounted fixation ring, (long)
 - comfort neck band
 - insertion aid (obturator)

REF.	ORDER SIZE/I.D.	QTY
121400	7.0 – 11.0	5

TRACHEOFIX TFCP SET
with cuff and phonation window



- SET COMPONENTS**
- tracheostomy tube
 - 4 colour-coded inner cannulas
 - 1 inner cannula with 15 mm connector, premounted fixation ring, (long)
 - 1 inner cannula with low-profile connector, (short)
 - 1 inner cannula with 15 mm connector, phonation, premounted fixation ring, (long)
 - 1 inner cannula with low-profile connector, phonation, (short)
 - fixation ring
 - cough cap
 - phonation valve with O₂-adapter
 - comfort neck band
 - insertion aid (obturator)

REF.	ORDER SIZE/I.D.	QTY
121410	7.0 – 11.0	5

TRACHEOFIX TFP SET
without cuff, with phonation window



- SET COMPONENTS**
- tracheostomy tube
 - 4 colour-coded inner cannulas
 - 1 inner cannula with 15 mm connector, premounted fixation ring, (long)
 - 1 inner cannula with low-profile connector, (short)
 - 1 inner cannula with 15 mm connector, phonation, premounted fixation ring, (long)
 - 1 inner cannula with low-profile connector, phonation, (short)
 - fixation ring
 - cough cap
 - phonation valve with O₂-adapter
 - comfort neck band
 - insertion aid (obturator)

REF.	ORDER SIZE/I.D.	QTY
121420	7.0 – 11.0	5

TRACHEOFIX TF SET
without cuff and phonation window







- SET COMPONENTS**
- tracheostomy tube
 - 2 colour-coded inner cannulas
 - 1 inner cannula with 15 mm connector, premounted fixation ring, (long)
 - 1 inner cannula with low-profile connector, (short)
 - fixation ring
 - cough cap
 - comfort neck band
 - insertion aid (obturator)

REF.	ORDER SIZE/I.D.	QTY
121415	7.0 – 11.0	5







TRACHEOFIX INNER CANNULA

- latex-free
- sterile
- single use

TRACHEOFIX INNER CANNULA						<i>RÜSCH</i>	
	REF.	ORDER SIZE	DESCRIPTION	I.D.	O.D.	QTY	
	121425	● 7.0	<ul style="list-style-type: none"> • 15 mm connector • premounted fixation ring 	5.5 mm	6.7 mm	10	
		● 8.5		7.0 mm	8.2 mm	10	
		● 10.0		8.5 mm	9.7 mm	10	
		● 11.0		9.5 mm	10.7 mm	10	
	121430	● 7.0	<ul style="list-style-type: none"> • low-profile connector • fixation ring 	5.5 mm	6.7 mm	10	
		● 8.5		7.0 mm	8.2 mm	10	
		● 10.0		8.5 mm	9.7 mm	10	
		● 11.0		9.5 mm	10.7 mm	10	
	121435	● 7.0	<ul style="list-style-type: none"> • 15 mm connector • premounted fixation ring • phonation 	5.5 mm	6.7 mm	10	
		● 8.5		7.0 mm	8.2 mm	10	
		● 10.0		8.5 mm	9.7 mm	10	
		● 11.0		9.5 mm	10.7 mm	10	
	121440	● 7.0	<ul style="list-style-type: none"> • low-profile connector • fixation ring • phonation 	5.5 mm	6.7 mm	10	
		● 8.5		7.0 mm	8.2 mm	10	
		● 10.0		8.5 mm	9.7 mm	10	
		● 11.0		9.5 mm	10.7 mm	10	

TRACHEOFIX ACCESSORIES

- single patient use

TRACHEOFIX ACCESSORIES				
	REF.	ORDER SIZE	DESCRIPTION	QTY
	121475	7.0	insertion aid	1
		8.5		1
		10.0		1
		11.0		1
	121445	–	sealing cap for • weaning	4
	121450	–	phonation valve • for 15 mm connectors with SoftMembrane technology • with O ₂ -adaptor	2
	121455	–	phonation valve • with SoftMembrane technology • with O ₂ -adaptor	2
	121460	–	cough cap	4
	121465	–	fixation ring to secure the TracheoFix inner cannula to low-profile connector	4

BIESALSKI

PRESHAPED TRACHEOSTOMY TUBE MADE OF THERMOSENSITIVE PVC

The Biesalski tube provides uncomplicated handling. In just a few movements, the inner cannula can be exchanged. Components such as standard connector, cough cap or phonation valve are connected securely to the tracheostomy tube by means of a bayonet fastener.

The special form of the Biesalski tube makes it possible to use it also as a phonation cannula which does not require a phonation opening.

 Size 6 available especially for paediatrics

- in the form of an arc, conical shape
- soft anatomically shaped fixation flange
- colour coding
- latex-free
- sterile
- single patient use

BIESALSKI SET
without cuff 



BIESALSKI SET COMPONENTS

- tracheostomy tube
- comfort neck band
- multifunctional connector set with bayonet fastener
 - 15 mm connector
 - phonation valve
 - cough cap
 - 2 colour-coded inner cannulas made of PVC

REF.	ORDER SIZE/I.D.	QTY
120900	4.0 – 13.0	5

EXTRA TRACHEOFLEX SET

RÜSCH

	ORDER SIZE/I.D.	O.D. (TIP)	O.D. (BEHIND FIXATION FLANGE)	TOTAL LENGTH (CLL=A+B+C)	DIM. A	DIM. B	DIM. C	ANGLE θ (APPROX.)	INNER CANNULA I.D./O.D.	QTY
Paed.	○ 4.0 mm	5.2 mm	7.15 mm	47.0 mm	–	–	47.0 mm	90°	2.7/3.7 mm	5
	● 5.0 mm	6.2 mm	8.20 mm	55.0 mm	–	–	55.0 mm	90°	3.7/4.7 mm	5
	● 6.0 mm	7.2 mm	9.25 mm	62.8 mm	–	–	62.8 mm	90°	4.6/5.6 mm	5
Adult	● 7.0 mm	8.2 mm	10.85 mm	62.8 mm	–	–	62.8 mm	90°	5.4/6.6 mm	5
	● 8.0 mm	9.3 mm	11.90 mm	70.6 mm	–	–	70.6 mm	90°	6.4/7.6 mm	5
	● 9.0 mm	10.4 mm	12.90 mm	70.6 mm	–	–	70.6 mm	90°	7.3/8.5 mm	5
	● 10.0 mm	11.4 mm	13.95 mm	70.6 mm	–	–	70.6 mm	90°	8.2/9.4 mm	5
	● 11.0 mm	12.4 mm	14.95 mm	78.5 mm	–	–	78.5 mm	90°	9.2/10.4 mm	5
	● 12.0 mm	13.5 mm	15.95 mm	78.5 mm	–	–	78.5 mm	90°	10.2/11.4 mm	5
	● 13.0 mm	14.6 mm	17.45 mm	83.2 mm	–	–	83.2 mm	90°	11.1/12.3 mm	5

TRACHEOSTOMY TUBES FOR PAEDIATRICS

Only the best is good enough for children. Tracheostomy tubes for paediatric use are anatomically designed and are manufactured with particular care. The atraumatic tip is gentle to the mucosa and facilitates gentle introduction

while the thermoplastic material conforms optimally to the child's anatomy. As a result of years of experience in the development of "small" tubes, RÜSCH helps to make tracheostomy as pleasant and safe as possible for children.

TRACHEOFLEX

ARMoured TUBE MADE OF THERMOSENSITIVE PVC

- siliconised
- atraumatic tip
- fixed 15 mm connector
- radiopaque
- latex-free
- sterile
- single patient use

TRACHEOFLEX SET without cuff



*movable fixation flange
with screw threaded ring*

SET COMPONENTS

- tracheostomy tube
- comfort neck band
- insertion aid (catheter)
- movable fixation flange with screw threaded ring

REF.	ORDER SIZE	QTY
120502	3.0	5
	4.0	5
	5.0	5
	6.0	5

TRACHEOFLEX TUBE

RÜSCH

I. D.	O. D.	TOTAL LENGTH (CLL=A+B+C)	DIM. A	DIM. B	DIM. C	ANGLE θ (APPROX.)
3.0 mm	5.0 mm	45.0 mm	11.0 mm	15.0 mm	19.0 mm	90°
4.0 mm	6.0 mm	55.0 mm	14.0 mm	21.0 mm	20.0 mm	90°
5.0 mm	7.0 mm	59.0 mm	18.0 mm	19.0 mm	22.0 mm	90°
6.0 mm	8.4 mm	64.0 mm	21.0 mm	19.0 mm	24.0 mm	90°

CRYSTALCLEAR PLUS

ADVANCED TUBE SYSTEM WITH A FLEXIBLE INNER CANNULA
SYSTEM MADE OF THERMOSENSITIVE PVC

- integrated rotating 15 mm connector
- with cuffed versions:
 - valve for Luer and Luer-lock syringe tips
 - blue pilot balloon
 - low-pressure cuff
- colour-coded tube neckplate
- continuous X-ray marker along the tube shaft
- latex-free
- sterile
- single use

CRYSTALCLEAR PLUS TUBE

RÜSCH

ORDER SIZE / I.D.	O.D.	TOTAL LENGTH (CLL=A+B+C)	DIM. A	DIM. B	DIM. C	ANGLE θ (APPROX.)	CUFF ø *	INNER CANNULA
● 3.5	5.3 mm	47 mm	17 mm	0	30 mm	95°	11 mm	–
○ 4.0	5.9 mm	54 mm	18 mm	0	36 mm	95°	12 mm	–
● 4.5	6.5 mm	54 mm	19 mm	0	35 mm	95°	14 mm	–
● 5.0	7.0 mm	57 mm	20 mm	0	37 mm	95°	14 mm	–
● 5.5	7.5 mm	58 mm	20 mm	0	38 mm	95°	15 mm	–
● 6.0	8.7 mm	64 mm	25.5 mm	0	38.5 mm	95°	19 mm	6.0
● 6.5	8.7 mm	64 mm	25.5 mm	0	38.5 mm	95°	19 mm	6.5

CRYSTALCLEAR PLUS SET with cuff

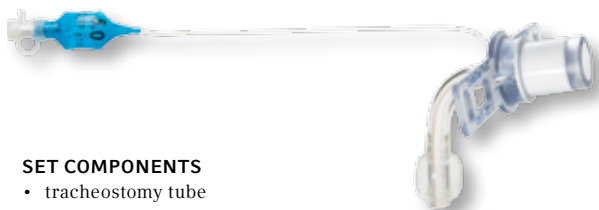

SET COMPONENTS

- tracheostomy tube
- 2 flexible inner cannulas with colour-coded stopper (≥ size 6)
- soft neck band
- insertion aid (obturator) (≥ size 6)
- water-soluble lubricating jelly, 3 g sachet

REF.	ORDER SIZE	QTY
121303	3.5–6.5	5

CRYSTALCLEAR PLUS SET without cuff



SET COMPONENTS

- tracheostomy tube
- 2 flexible inner cannulas with colour-coded stopper (≥ size 6)
- soft neck band
- insertion aid (obturator) (≥ size 6)
- water-soluble lubricating jelly, 3 g sachet

REF.	ORDER SIZE	QTY
121300	3.5–6.5	5

INNER CANNULAS & ACCESSORIES

available separately, see page 12

BIESALSKI

TRACHEOSTOMY TUBE MADE OF THERMOSENSITIVE PVC

- in the form of an arc, conical shape
- soft anatomically shaped fixation flange
- colour coding
- latex-free
- sterile
- single patient use

BIESALSKI SET
without cuff





SET COMPONENTS
BIESALSKI SET

- tracheostomy tube
- comfort neck band
- multifunctional connector set with bayonet fastening
 - 15 mm connector
 - phonation valve
 - cough cap
 - 2 colour-coded inner cannulas made of PVC

REF.	ORDER SIZE/I.D.	QTY
120900	4.0 -6.0	5

BIESALSKI SET

RUSCH

ORDER SIZE/I.D.	O.D. (TIP)	O.D. (BEHIND FIXATION FLANGE)	TOTAL LENGTH (CLL=A+B+C)	DIM. A	DIM. B	DIM. C	ANGLE θ (APPROX.)	INNER CANNULA I.D./O.D.
○ 4.0 mm	5.2 mm	7.15 mm	47.0 mm	-	-	47.0 mm	90°	2.7/3.7 mm
● 5.0 mm	6.2 mm	8.2 mm	55.0 mm	-	-	55.0 mm	90°	3.7/4.7 mm
● 6.0 mm	7.2 mm	9.25 mm	62.8 mm	-	-	62.8 mm	90°	4.6/5.6 mm

PERCUTANEOUS TRACHEOSTOMY (PDT)

All methods facilitate endoscopic monitoring and continuous ventilation. For each method we can offer you well-matched sets as well as an extensive range of set components which can be ordered separately.

Depending on their intended use, the sets can be freely combined. The PercuQuick and PercuTwist sets are pre-

configured; with the “Solo set” you choose the tube. The high-quality tracheostomy tubes come with tips especially adapted to the corresponding dilators. Thanks to the use of thermosensitive materials, a hydrophilic coating and flexible fixation flanges, these tracheostomy tubes, in connection with the introduction dilators specifically developed for PDT, are the best choice.

THE CONVENTIONAL METHOD: PERCUQUICK MULTI-STEP DILATOR SET

Gentle step-by-step dilation helps reduce infections as well as supporting rapid healing coupled with excellent cosmetic results.

THE ALL-IN-ONE METHOD: PERCUQUICK ONE-STEP DILATOR

Dilation is carried out with only one instrument. The results can be compared to those achieved with the Multi-Step method.

THE REVOLUTIONARY METHOD: PERCUTWIST ONE-STEP DILATOR

This new patented single-step dilator has for the first time made percutaneous tracheostomy a controllable and genuinely safe procedure.

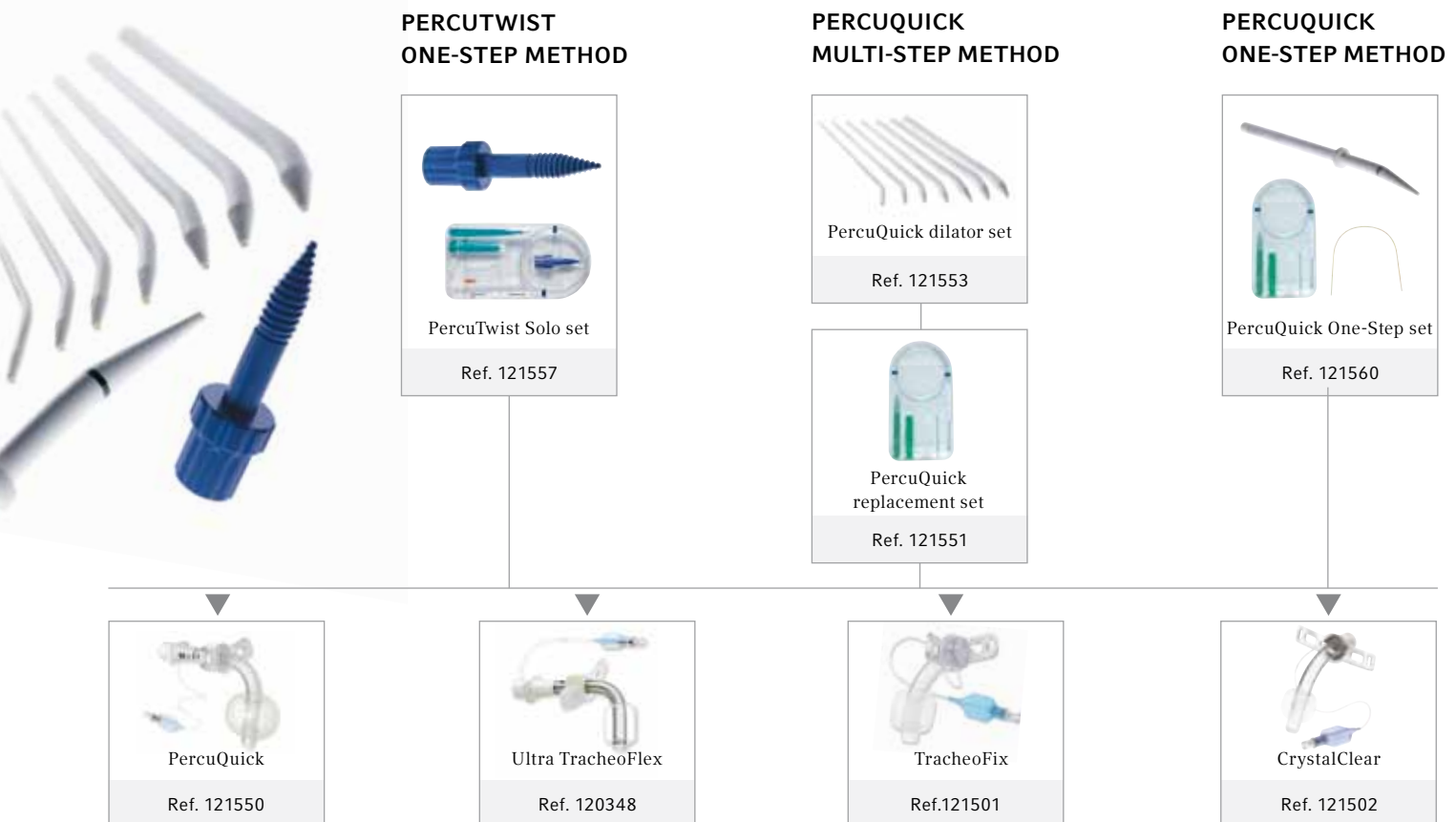

PDT TRACHEOSTOMY TUBE SETS

PERCUQUICK PDT

RÜSCH

I.D. (MM)	O.D. (MM)	TOTAL LENGTH (CLL=A+B+C)	DIM. A (MM)	DIM. B (MM)	DIM. C (MM)	ANGLE θ (APPROX.)	CUFF Ø (MM)
7.0	10.7	117.0 mm	42.0	47.0	28.0	90°	27
8.0	11.7	134.0 mm	42.0	57.0	35.0	90°	32
9.0	12.7	154.0 mm	42.0	77.0	35.0	90°	32



SET COMPONENTS

- tracheostomy tube with low-pressure cuff
- movable fixation flange, with simple and safe locking mechanism
- comfort neck band
- introduction dilator
- sterile
- single use

REF.	ORDER SIZE	QTY
121550	7.0/8.0/9.0	1

TRACHEOFIX PDT

RÜSCH

I.D. (MM)	O.D. (MM)	TOTAL LENGTH (CLL=A+B+C)	DIM. A (MM)	DIM. B (MM)	DIM. C (MM)	ANGLE θ (APPROX.)	CUFF Ø (MM)
7.0	9.0	70.0 mm	–	–	70.0	78°	27
8.5	10.3	78.0 mm	–	–	78.0	86°	27
10.0	12.3	86.0 mm	–	–	86.0	90°	32



SET COMPONENTS

- tracheostomy tube with low-pressure cuff
- flexible fixation flange
- comfort neck band
- introduction dilator
- sterile
- single use

REF.	ORDER SIZE	QTY
121501	7.0/8.5/10.0	1

ULTRA TRACHEOFLEX PDT

RÜSCH

I.D. (MM)	O.D. (MM)	TOTAL LENGTH (CLL=A+B+C)	DIM. A (MM)	DIM. B (MM)	DIM. C (MM)	ANGLE θ (APPROX.)	CUFF Ø (MM)
7.0	10.4	63.0 mm	32.0	3.0	28.0	90°	22
8.0	11.4	88.0 mm	32.0	21.0	35.0	90°	24
9.0	12.4	117.0 mm	42.0	40.0	35.0	90°	25



SET COMPONENTS

- tracheostomy tube with low-pressure cuff, armoured
- movable fixation flange, with simple and safe locking mechanism
- comfort neck band
- introduction dilator
- sterile
- single use

REF.	ORDER SIZE	QTY
120348	7.0/8.0/9.0	1

CRYSTALCLEAR PDT

RÜSCH

I.D. (MM)	O.D. (MM)	TOTAL LENGTH (CLL=A+B+C)	DIM. A (MM)	DIM. B (MM)	DIM. C (MM)	ANGLE θ (APPROX.)	CUFF Ø (MM)
7.5	10.0	70.0 mm	29.2	–	40.8	95°	22
8.5	11.3	81.0 mm	35.5	–	45.5	95°	24
9.5	12.7	87.0 mm	39.9	–	47.1	95°	25



SET COMPONENTS

- tracheostomy tube with low-pressure cuff
- flexible fixation flange
- comfort neck band
- introduction dilator
- sterile
- single use

REF.	ORDER SIZE	QTY
121502	7.0/8.0/9.0	1

PERCUTWIST



THE REVOLUTIONARY METHOD: PERCUTWIST ONE-STEP DILATOR

Safe, quick, gentle: This patented single-step dilator has made a percutaneous tracheostomy a controllable and genuinely safe procedure for the first time and has thus set new standards. It comes with an application which is surprisingly simple and gentle. Rapid healing of the tracheostoma with best cosmetic results is the norm. Its unique design with a dilating thread makes it possible to lift the tracheal anterior wall while simultaneously dilating through simple rotation. An unrestricted endoscopic view of the dilation site is guaranteed at any given time.

- hydrophilic coating reduces the force needed for penetration
- three different diameters enable optimum application of rotary forces while penetrating the tissue

Practical and time-saving: The PercuTwist Set is available with either the PercuQuick or CrystalClear tracheostomy tube – both equally compatible.

Free choice: With the PercuTwist SOLO Set you choose the tube depending on application. The tubes fit the introducing dilator precisely and thus guarantee smooth and gentle introduction through the stoma.

PERCUTWIST ACCESSORIES

All products are in individual sterile packaging.

PERCUTWIST XXL HANDLE			<i>RÜSCH</i>
	REF.	DESCRIPTION	QTY
	121558	handle to be attached to the PercuTwist dilator to increase the torque • sterile, single use	2
FIRST-STEP DILATOR			<i>RÜSCH</i>
	REF.	DESCRIPTION	QTY
	121503	dilator for initial dilation of the trachea O.D. 2.2–6 mm • sterile, single use	5

COMPLETE SETS

PERCUTWIST SET WITH PERCUQUICK

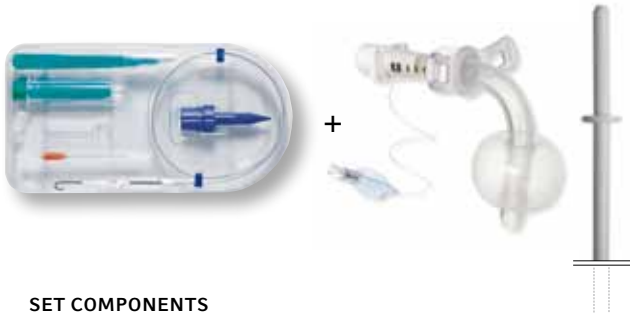

SET COMPONENTS

- PercuTwist dilator
- PercuQuick tracheostomy tube with introduction dilator
- guide wire with J-tip and insertion aid
- puncturing cannula 17G x 70mm/14G x 52mm
- scalpel
- Luer-lock syringe
- neck band
- latex-free
- sterile
- single use

REF.	SIZE MM	QTY
121555	7.0/8.0/9.0	1

PERCUTWIST SET WITH CRYSTALCLEAR

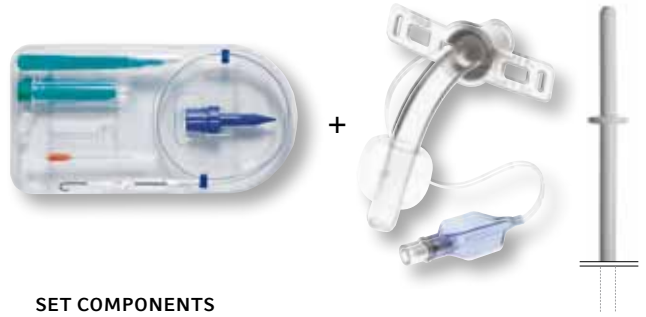

SET COMPONENTS

- PercuTwist dilator
- CrystalClear tracheostomy tube with introduction dilator
- guide wire with J-tip and insertion aid
- puncturing cannula 17G x 70mm/14G x 52mm
- scalpel
- Luer-lock syringe
- neck band
- latex-free
- sterile
- single use

REF.	SIZE MM	QTY
121556	7.0/8.0/9.0	1

COMBINATION POSSIBILITIES

PERCUTWIST SOLO SET



SET COMPONENTS

- PercuTwist dilator
- guide wire with J-tip and insertion aid
- puncturing cannula
- scalpel
- Luer-lock syringe
- neck band
- latex-free
- sterile
- single use

REF.	SIZE MM	QTY
121557	7.0/8.0/9.0	1

+

- Ref. 121550
Sizes: I.D. 7.0/8.0/9.0 mm
- Ref. 120348
Sizes: I.D. 7.0/8.0/9.0 mm
- Ref. 121501
Sizes: I.D. 7.0/8.0/9.0 mm
- Ref. 121502
Sizes: I.D. 7.0/8.0/9.0 mm

The sizes indicated always correspond to the size of the tracheostomy tube used (see page 21)

PERCUQUICK® MULTI-STEP

THE CONVENTIONAL METHOD: PERCUQUICK MULTI-STEP DILATOR SET

The PercuQuick Multi-Step set with its first-step dilator and a further seven dilators that are staggered in size, the tips of which are equipped with a hydrophilic coating, enables the atraumatic dilation of the tracheostoma thus reducing the risk of complications.



- the hydrophilic coating of the tip facilitates dilation and reduces the forces needed for penetration
- the tip of the rüsch tracheostomy tubes have been specifically adapted to the dilators, thus enabling gentle passage through the tracheostoma

PERCUQUICK SET



SET COMPONENTS

- complete set with dilators and yellow guide sleeve
- application set with First-Step dilator, puncturing cannula, scalpel, Luer-lock syringe, neck band and guidewire with J-tip
- PercuQuick tracheostomy tube with low-pressure cuff and introduction dilator
- sterile
- single use

REF.	SIZE MM	QTY
121549	7.0/8.0/9.0	1

The sizes indicated always correspond to the size of the tracheostomy tube used (see p. 21)

COMBINATION OPTIONS WITH OUR TUBES

PERCUQUICK REPLACEMENT SET

SET COMPONENTS

- application set with First-Step dilator, puncturing cannula, scalpel, Luer-lock syringe, neck band and guidewire with J-tip
- sterile
- single use

REF.	QTY
121551	1



PERCUQUICK DILATOR SET

SET COMPONENTS

- set with 7 dilators and yellow guide sleeve
- sterile
- single use

REF.	QTY
121553	1



+



Ref. 121550
Sizes: I.D. 7.0/8.0/9.0 mm



Ref. 120348
Sizes: I.D. 7.0/8.0/9.0 mm



Ref. 121501
Sizes: I.D. 7.0/8.0/9.0 mm



Ref. 121502
Sizes: I.D. 7.0/8.0/9.0 mm

PERCUQUICK® ONE-STEP

THE ALL-IN-ONE METHOD:

PERCUQUICK ONE-STEP DILATOR

Dilation is carried out with only one instrument. The PercuQuick One-Step dilator offers optimum dilation properties thanks to its hydrophilic coating.

- the special shape of the One-Step tip enables dilation in just one step
- now with stopper – for increased safety and better handling



PERCUQUICK ONE-STEP DILATOR		<i>RÜSCH</i>
REF.	ORDER SIZE/O.D.	QTY
121565	7.0/8.0/9.0 mm	1

PERCUQUICK ONE-STEP SET

SET COMPONENTS

- application set with First-Step dilator, puncturing cannula, scalpel, Luer-lock syringe and guidewire with J-tip
- yellow guide sleeve
- PercuQuick One-Step dilator
- sterile
- single use



REF.	ORDER SIZE	QTY
121560	7.0/8.0/9.0	1

SPECIAL PRODUCTS

Prepared for everything. From an emergency procedure to the operating theatre – the perfectly coordinated special sets from Teleflex’s RÜSCH brand put everything within grasp for every application, in the correct size and in sterile packaging. This allows optimal care of the patient and safe and economical work.

TracheoQuick, the emergency coniotomy set, contains everything needed for rapid intervention in the case of obstruction of the upper respiratory tract, when intubation

or ventilation are not possible. The unique double-lumen TracheoPart tracheostomy tubes enable the two sides to be ventilated separately. The flexible LaryngoFlex tracheostomy tube is the safe and proven solution for tracheostomy patients during anaesthesia. TPS Multiflex is used to gently shorten the weaning phase of tracheostomy patients. The tracheostoma retainer is characterised by high patient tolerability as well as simple and safe handling.

TRACHEOQUICK EMERGENCY CONIOTOMY SET

- pre-assembled coniotomy set, ready to use
- conical introduction dilator made of stainless steel
- coniotomy tube made of plastic
- 15 mm connector
- fixation plate
- mounted stopper
- latex-free
- sterile
- single use

TRACHEOQUICK CONIOTOMY TUBE		RÜSCH
ORDER SIZE/I.D.	O.D.	
2.0 mm	2.8 mm	
4.0 mm	4.8 mm	

TRACHEOQUICK PLUS CONIOTOMY TUBE		RÜSCH
ORDER SIZE/I.D.	O.D.	
4.0 mm	5.0 mm	

TRACHEOQUICK SET without cuff

SET COMPONENTS

- coniotomy tube
- flexible tube extension made of silicone with connectors
- scalpel
- one-way syringe & comfort neck band pre-assembled with tube



REF.	ORDER SIZE/I.D.	QTY
120600	2.0, 4.0	1

TRACHEOQUICK PLUS SET with cuff

SET COMPONENTS

- coniotomy tube
- flexible tube extension made of silicone with connectors
- scalpel
- one-way syringe & comfort neck band pre-assembled with tube



REF.	ORDER SIZE/I.D.	QTY
120604	4.0	1

TRACHEOPART

DOUBLE-LUMEN TRACHEOSTOMY BRONCHIAL TUBE FOR LATERALLY SEPARATED VENTILATION
MADE OF THERMOSENSITIVE PVC

- valve for Luer and Luer-lock syringe tips
- integrated rotary 15 mm connector
- open transparent fixation flange
- continuous X-ray marker
- latex-free
- sterile
- single use

TRACHEOPART TUBE DOUBLE LUMEN TRACHEOSTOMY BRONCHIAL TUBE

RÜSCH

ORDER SIZE	2 X I.D.	O.D.	CUFF Ø BRONCHIAL	CUFF Ø TRACHEAL	REF. 116400 LENGTH OF SHAFT	REF. 116401 LENGTH OF SHAFT	LENGTH OF INTRA- TRACHEAL LIMB
7.5 mm	4.76 mm	13.9 mm	18.0 mm	26.0 mm	180.0 mm	190.0 mm	75.0 mm
8.5 mm	4.76 mm	13.9 mm	18.0 mm	26.0 mm	190.0 mm	200.0 mm	85.0 mm
9.5 mm	4.76 mm	13.9 mm	18.0 mm	26.0 mm	200.0 mm	210.0 mm	95.0 mm

TRACHEOPART SET

for left-sided bronchial intubation

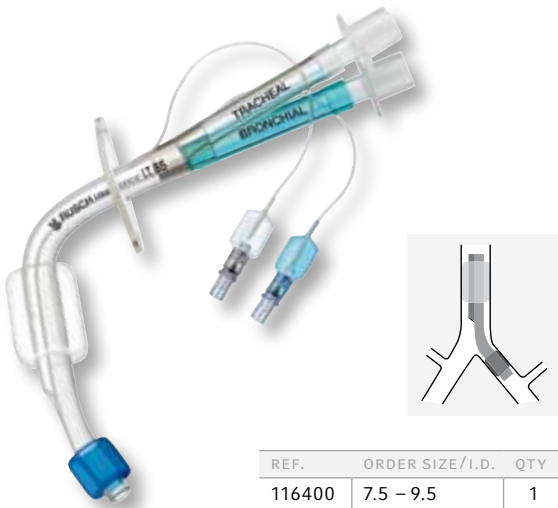

SET COMPONENTS

- tracheostomy tube
- 2 suction catheters
- 2 angled connecting pieces with extension and closable openings for bronchoscopy
- Y-connector
- comfort neck band

TRACHEOPART SET

for right-sided bronchial intubation

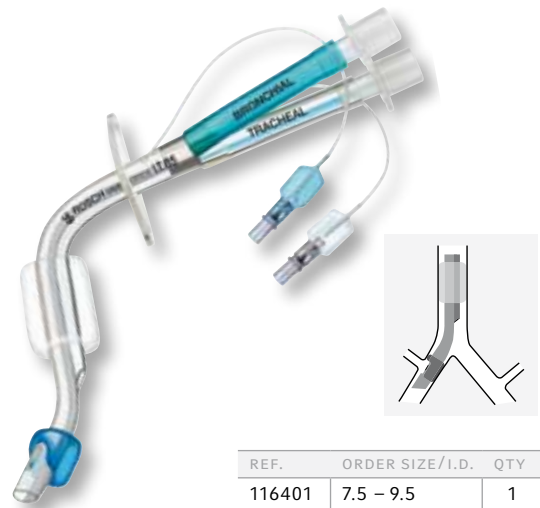

SET COMPONENTS

- tracheostomy tube
- 2 suction catheters
- 2 angled connecting pieces with extension and closable openings for bronchoscopy
- Y-connector
- comfort neck band

LARYNGOFLEX

**ARMOURED FLEXIBLE TRACHEOSTOMY TUBE, FOR LARYNGECTOMIES
MADE OF THERMOSENSITIVE PVC**

- siliconised
- anatomically shaped
- thin-walled low-pressure cuff:
 - valve for Luer and Luer-lock syringe tips
 - blue pilot balloon
 - low-pressure cuff
- fixed white 15 mm connector
- radiopaque
- latex-free
- sterile
- single use



LARYNGOFLEX WITHOUT FIXATION FLANGE

- with valve for Luer and Luer-lock syringe tips
- also available in size 11.0

REF.	ORDER SIZE/I.D.	DESCRIPTION	QTY
121181	7.0–11.0	w/o fixation flange	2

LARYNGOFLEX WITH FIXATION FLANGE

- with valve for Luer and Luer-lock syringe tips
- new fixation flange design with unique locking mechanism
- not available in size 11.0

REF.	ORDER SIZE/I.D.	DESCRIPTION	QTY
121182	7.0–10.0	with fixation flange	2

LARYNGOFLEX TUBE

RUSCH

ORDER SIZE/I.D.	O.D.	TOTAL LENGTH (CLL=A+B+C)	DIM. A	DIM. B	DIM. C	ANGLE θ (APPROX.)	CUFF Ø
7.0 mm	10.4 mm	270.0 mm	30.0 mm	173.0 mm	67.0 mm	180°	22 mm
8.0 mm	11.4 mm	270.0 mm	34.0 mm	164.0 mm	72.0 mm	180°	24 mm
9.0 mm	12.4 mm	280.0 mm	42.0 mm	161.0 mm	77.0 mm	180°	25 mm
10.0 mm	13.4 mm	290.0 mm	41.0 mm	167.0 mm	82.0 mm	180°	26 mm
11.0 mm	14.4 mm	290.0 mm	41.0 mm	167.0 mm	82.0 mm	180°	28 mm

TPS MULTIFLEX

ARMoured TRACHEOSTOMY RETAINER

- armoured retainer with intratracheal disc, made of silicone
- evenly spaced armoured sections to allow for length alteration
- latex-free
- sterile
- single patient use

 Size 6 available especially for paediatric use



a) Movable fixation flange with unique locking mechanism in sizes I.D. 8.0 and 10.0 mm



b) Fixation flange with screw threaded ring in size I.D. 6.0 mm

TPS MULTIFLEX RETAINER

RÜSCH

	ORDER SIZE/I.D.	O.D.	TOTAL LENGTH (CLL=A+B+C)	FIXATION FLANGE TYPE
Paed.	6.0 mm	8.3 mm	110.0 mm	b
Adult	8.0 mm	11.4 mm	110.0 mm	a
	10.0 mm	13.4 mm	110.0 mm	a

TPS MULTIFLEX SET

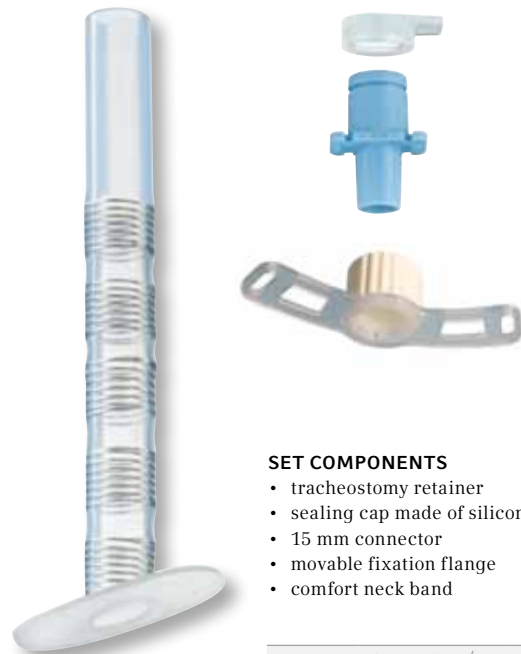

SET COMPONENTS



- tracheostomy retainer
- sealing cap made of silicone
- 15 mm connector
- movable fixation flange
- comfort neck band

REF.	ORDER SIZE/I.D.	QTY
120460	6.0-10.0	1

ACCESSORIES





COMFORT NECK BAND

RUSCH

	REF.	DESCRIPTION	QTY
 	507900	<ul style="list-style-type: none"> fits all tracheostomy tubes single use 	10
	507800	Comfort neck band for paediatric use (not illustrated) <ul style="list-style-type: none"> extra small version single use 	10

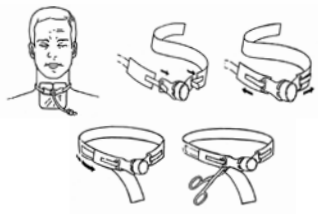

COMFORT NECK BAND, SIZE L

RUSCH

	REF.	DESCRIPTION	QTY
   	507906	<ul style="list-style-type: none"> 2-piece neck band for tracheostomy tubes progressively adjustable and easily positioned velcro fastener, secure and easy to fix non-irritant with cotton exterior and moisture-transporting soft inner layer specially designed for prolonged use and patients with sensitive skin latex-free ready to use single use individually packed 	20

TRACHFIT NECK BAND, FITS ADULTS AND CHILDREN

RUSCH

	REF.	DESCRIPTION	QTY
 	968671	<ul style="list-style-type: none"> beige coloured 3-piece neck band for tracheostomy tubes progressively adjustable and easily positioned velcro fastener, secure and easy to fix latex-free sterile single use individually packed 	10

WOUND DRESSING FOR TRACHEOSTOMA

RUSCH

	REF.	DESCRIPTION	QTY
	507907	<ul style="list-style-type: none"> special oblique slit to fit optimally around the tracheostomy tube three-layer highly absorbent material composition non-adherent latex-free sterile single use dimensions: 93 mm x 95 mm individually packed 	25

SPIRO

	REF.	DESCRIPTION	QTY
	121800	Spiro phonation valve set consisting of: <ul style="list-style-type: none"> • housing with phonation valve and filter • housing with filter, without phonation valve • deflector • connectors for silver cannulas • tweezers <ul style="list-style-type: none"> • with oxygen port • single patient use 	1
	121801	Spiro filter housing with phonation valve <ul style="list-style-type: none"> • single patient use 	5
	121802	Spiro filter housing without phonation valve <ul style="list-style-type: none"> • single patient use 	5
	121803	Spiro filter for Spiro filter housing 121800/121801/121802 <ul style="list-style-type: none"> • single use 	100
	121804	Spiro deflector <ul style="list-style-type: none"> • single patient use 	5

PHONATION VALVE

	REF.	DESCRIPTION	QTY
	506500	<ul style="list-style-type: none"> • H.J. Lubbers pattern • fits all tracheostomy tubes with 15 mm connectors • latex-free • sterile • single patient use 	10

PHONATION VALVE

	REF.	DESCRIPTION	QTY
	507500	<ul style="list-style-type: none"> • H.J. Lubbers pattern, fits Biesalski tube • 4 mm for tube size 4–7 • 8 mm for tube size 8–10 • 11 mm for tube size 11–13 • single patient use 	5

SOFT MEMBRANE PHONATION VALVE

	REF.	DESCRIPTION	QTY
	121450	<ul style="list-style-type: none"> • for 15 mm connectors • Soft Membrane technology and O₂-adapter • single patient use 	2

TRACHEAL DILATOR

	REF.	DESCRIPTION	QTY
	P0411026	<ul style="list-style-type: none"> • tracheal dilator, 3 branches 	1



FORCEPS

	REF.	DESCRIPTION	QTY
	KM57178	<ul style="list-style-type: none"> • forceps, angular 	1



CLEANING BRUSHES

	REF.	DESCRIPTION	QTY
	968675	<ul style="list-style-type: none"> • Size 6 mm for tube I.D. 3–6 mm • Size 10 mm for tube I.D. 7–9 mm • Size 15 mm for tube I.D. 10–13 mm 	10

TRACH-VENT

	REF.	DESCRIPTION	QTY
	41111	<ul style="list-style-type: none"> • heat and moisture exchanger • suitable for adults and children for tidal volume (TV) > 50 ml • sterile 	50
	41112	<ul style="list-style-type: none"> • heat and moisture exchanger • suitable for adults and children from tidal volume (TV) > 50 ml • clean packed 	50
	61112	<ul style="list-style-type: none"> • holder for artificial nose Trach-Vent 	30
	41172	<ul style="list-style-type: none"> • starter kit • contains 3 Trach-Vents, 1 Trach-Vent holder and 1 Oxy-Vent with tubing 	6

OXY-VENT

	REF.	DESCRIPTION	QTY
	45512	<ul style="list-style-type: none"> • for oxygen supply 	10
	49912	<ul style="list-style-type: none"> • for oxygen supply • with tubing 	20

TRACH-VENT+

	REF.	DESCRIPTION	QTY
	41311	<ul style="list-style-type: none"> • excellent humidification performance • suitable for adults and children for tidal volume (TV) > 50 ml • sterile 	50
	41312	<ul style="list-style-type: none"> • excellent humidification performance • suitable for adults and children from tidal volume (TV) > 50 ml • clean packed 	50

TRACHJELL LUBRICATING JELLY

	REF.	DESCRIPTION	QTY
	556100	<ul style="list-style-type: none"> • water soluble lubricating gel • 8.5 g • sterile 	25



HUMID-VENT MINI

	REF.	DESCRIPTION	QTY
	10011	<ul style="list-style-type: none"> • heat and moisture exchanger • for tidal volume (TV) 15–50 ml • sterile 	30
	10012	<ul style="list-style-type: none"> • heat and moisture exchanger • for tidal volume (TV) 15–50 ml • clean packed 	30

AQUA+ TS

	REF.	DESCRIPTION	QTY
	41574	<ul style="list-style-type: none"> • safety valve • O₂-port • for tidal volume (TV) 75–1000 ml 	30

TRACHEOSTOMY MASK

	REF.	DESCRIPTION	QTY
	1075	<ul style="list-style-type: none"> • adult • for aerosol therapy with adults • swivel connector 	50
	41076	<ul style="list-style-type: none"> • paediatric • for aerosol therapy with children • swivel connector 	50

ENDOTEST

	REF.	DESCRIPTION	QTY
	112700	Apparatus for filling and monitoring the pressure of low-pressure cuffs on tracheal, tracheostomy and bronchial tubes <ul style="list-style-type: none"> • with connecting tube 	1

CONNECTING TUBE MADE OF PVC

	REF.	DESCRIPTION	QTY
	230100	<ul style="list-style-type: none"> • transparent, latex-free, with Luer adapter (male and female) • approx. 100 cm long, 2.0 x 3.0 mm 	1

INDEX

REF.	DESIGNATION	PAGE
10011	Humid-vent Mini, sterile	32
10012	Humid-vent Mini, clean	32
1075	Tracheostomy mask	32
112700	Endotest	32
116400	TracheoPart	27
116401	TracheoPart	27
120000	TracheoFlex S set	8
120001	TracheoFlex S set	8
120100	TracheoFlex S set	9
120101	TracheoFlex S set	9
120204	Extra TracheoFlex set	7
120304	Ultra TracheoFlex set	5
120347	Ultra TracheoFlex set	5
120348	Ultra TracheoFlex set PDT	21
120378	Ultra TracheoFlex set	5
120460	TPS MultiFlex set	29
120502	TracheoFlex set	6
120502	TracheoFlex set for paediatrics	17
120504	TracheoFlex set	6
120600	TracheoQuick set	26
120604	TracheoQuick Plus set	26
120900	Biesalski set	16
120900	Biesalski set for paediatrics	19
121181	LaryngoFlex	28
121182	LaryngoFlex	28
121300	CrystalClear Plus set	11
121300	CrystalClear Plus set for paediatrics	18
121303	CrystalClear Plus set	11
121303	CrystalClear Plus set for paediatrics	18
121310	CrystalClear Plus inner cannula	12
121311	CrystalClear Plus shower cap	12
121312	CrystalClear Plus cough cap	12
121313	CrystalClear Plus sealing cap	12
121400	TracheoFix set TFC	14
121410	TracheoFix set TFCP	14
121415	TracheoFix set TF	14
121420	TracheoFix set TFP	14
121425	TracheoFix inner cannula	15
121430	TracheoFix inner cannula	15
121435	TracheoFix inner cannula	15
121440	TracheoFix inner cannula	15
121445	TracheoFix sealing cap	15
121450	TracheoFix SoftMembrane phonation valve	15/31
121455	TracheoFix SoftMembrane phonation valve	15
121460	TracheoFix cough cap	15
121465	TracheoFix fixation ring	15
121475	TracheoFix insertion aid	15
121500	SafetyClear set	12

REF.	DESIGNATION	PAGE
121501	TracheoFix PDT	21
121502	CrystalClear PDT	21
121503	PercuTwist First-Step dilator	22
121549	PercuQuick tracheostomy set	24
121550	PercuQuick PDT	21
121551	PercuQuick replacement set	25
121553	PercuQuick dilator set	25
121555	PercuTwist set with PercuQuick	23
121556	PercuTwist set with CrystalClear	23
121557	PercuTwist set Solo	23
121558	PercuTwist XXL handle	22
121560	PercuQuick One-Step set	25
121565	PercuQuick One-Step dilator	25
121800	Spiro phonation valve set	31
121801	Spiro filter housing	31
121802	Spiro filter housing	31
121803	Spiro deflector	31
121804	Spiro filter	31
121900	TracFlex Plus set	3
121903	TracFlex Plus set	3
121910	TracFlex Plus inner cannula	3
121911	TracFlex Plus shower cap	3
121912	TracFlex Plus cough cap	3
121913	TracFlex Plus sealing cap	3
121915	TracFlex Plus insertion aid	3
230100	Connecting tube PVC	32
41076	Tracheostomy mask	32
41111/12	Trach-Vent	32
41172	Trach-Vent starter kit	32
41311/12	Trach-Vent+	32
41574	Aqua+ TS	32
45512	Oxy-Vent with tube	32
49912	Oxy-Vent without tube	32
506500	Phonation valve, H.J. Lubbers pattern	31
507500	Phonation valve, H.J. Lubbers, for Biesalski	31
507800	Comfort neck band, blue, for paediatrics	30
507900	Comfort neck band, blue	30
507906	Comfort neck band, white	30
507907	Wound dressing	30
556100	TrachJell	32
61112	Trach-Vent holder	32
858135	Tracheoflex S inner cannula	9
968671	Neck band TrachFit	30
968675	Cleaning brushes	31
PO411026	Tracheal dilator	31
KM57178	Forceps, angular	31

Teleflex is a global provider of medical products designed to enable healthcare providers to protect against infections and improve patient and provider safety. The company specialises in products and services for vascular access, respiratory, general and regional anaesthesia, cardiac care, urology and surgery. Teleflex also provides specialty products for device manufacturers.

The Teleflex family of brands includes ARROW[®], BEERE MEDICAL[®], DEKNATEL[®], GIBECK[®], HUDSON RCI[®], KMEDIC[®], PILLING[®], PLEUR-EVAC[®], RÜSCH[®], SHERIDAN[®], SMD[™], TAUT[®], TFX OEM[®] and WECK[®], all of which are trademarks or registered trademarks of Teleflex Incorporated or its affiliates. Teleflex Incorporated (NYSE:TFX) has annual revenues of approximately \$1.9 billion and serves healthcare providers in 140 countries.

Teleflex global operations: Austria, Belgium, Canada, China, Czech Republic, France, Germany, Greece, India, Ireland, Italy, Japan, Mexico, Netherlands, Portugal, Singapore, Slovak Republic, South Africa, Spain, Switzerland, United Kingdom, Uruguay and USA.

YOUR CONTACTS FOR EUROPE, THE MIDDLE EAST AND AFRICA (EMEA):

TELEFLEX MEDICAL HEADQUARTERS EMEA, IRELAND

Teleflex Medical Europe Ltd., IDA Business Park, Athlone, Co Westmeath
Phone +353 (0)9 06 46 08 00 · Fax +353 (0)14 37 07 73
orders.intl@teleflexmedical.com

AUSTRIA +43 (0)1 402 47 72

BELGIUM +32 (0)2 333 24 60

CZECH REPUBLIC +420 (0)495 759 111

FRANCE +33 (0)5 62 18 79 40

GERMANY +49 (0)7151 406 0

GREECE +30 210 67 77 717

ITALY +39 0362 58 911

NETHERLANDS +31 (0)88 00 215 00

PORTUGAL +351 22 541 90 85

SLOVAK REPUBLIC +421 (0)3377 254 28

SOUTH AFRICA +27 (0)11 807 4887

SPAIN +34 918 300 451

SWITZERLAND +41 (0)31 818 40 90

UNITED KINGDOM +44 (0)1494 53 27 61

For detailed information see www.teleflex.com

The products in this catalogue are only available in the EMEA (Europe, Middle East, Africa) region. For further information contact your local representative. All data current at time of printing (02/2011). Subject to technical changes without further notice.

93 99 40 - 00 00 11 · REV A · MC / SF · 02 11 04